

**5' x 19' SKYLIGHT**  
S-519-3A

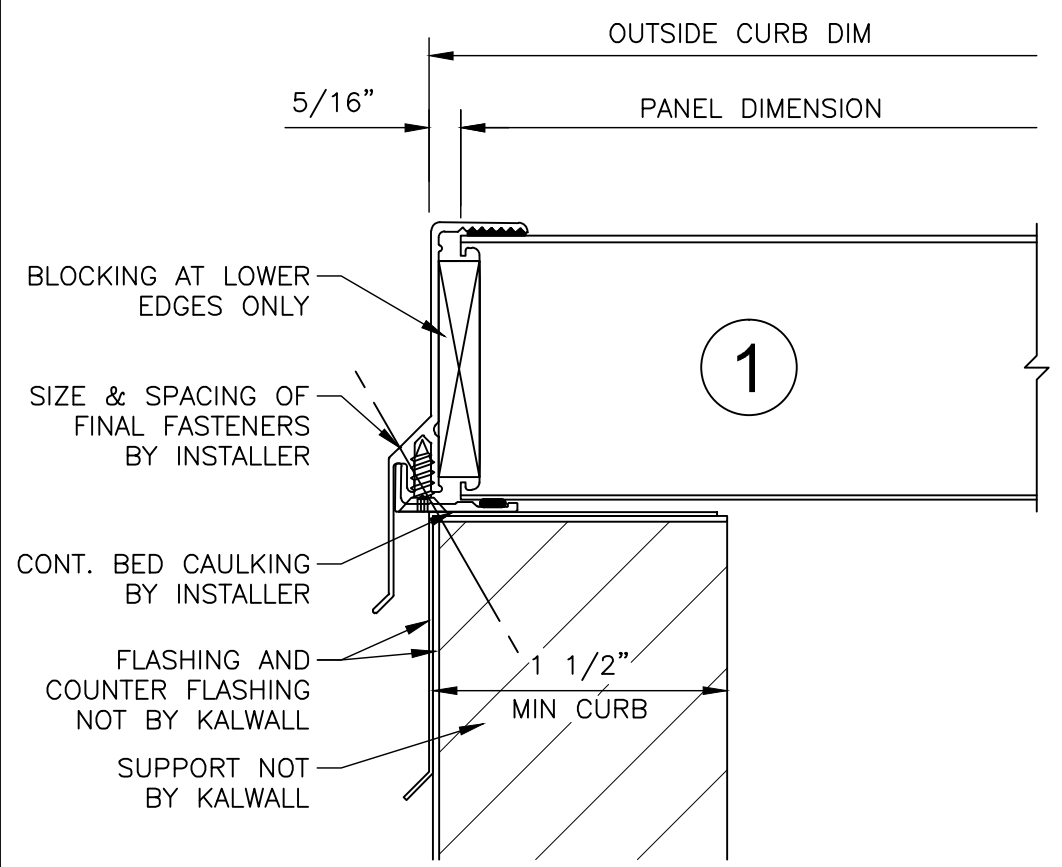

**KALWALL**<sup>®</sup>  
high performance translucent building systems